



Ordering Angles

Name _____

Score _____

TI:20

Name the smallest and largest angle in each triangle.

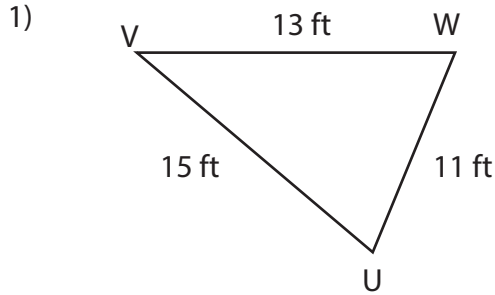

Smallest angle :

Largest angle :

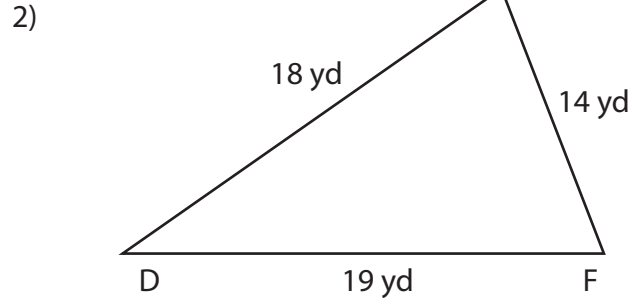

Smallest angle :

Largest angle :

Order the angles from smallest to largest angle in each triangle.

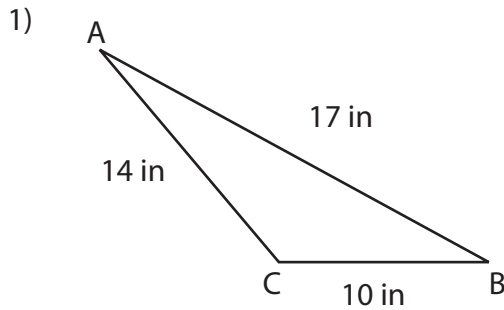

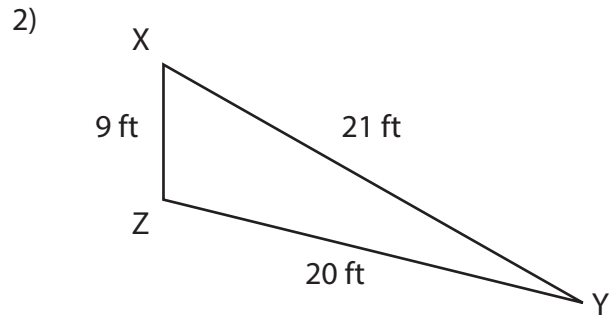

Order the angles from largest to smallest angle in each triangle.

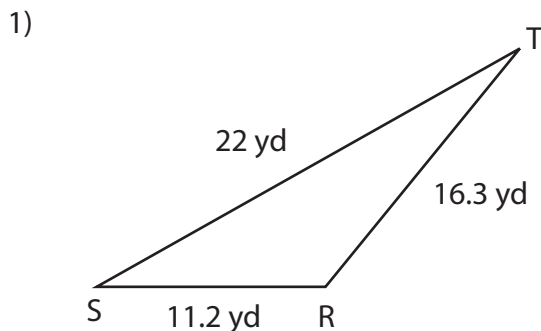

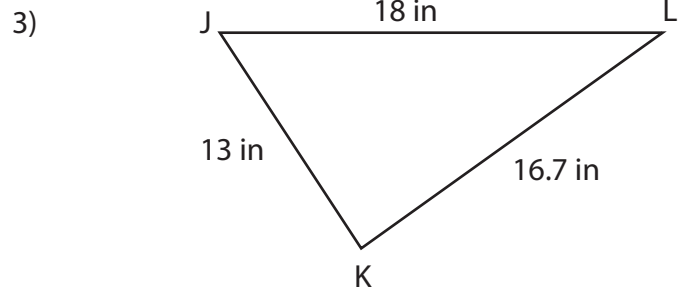



Ordering Angles

Name _____

Score _____

Answer key

TI:20

Name the smallest and largest angle in each triangle.

1)

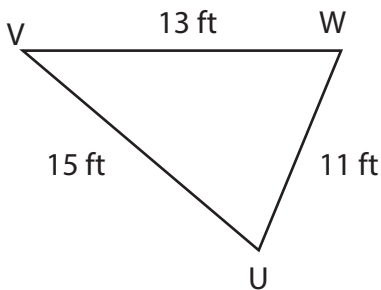

Smallest angle :

$\angle V$

Largest angle :

$\angle W$

2)

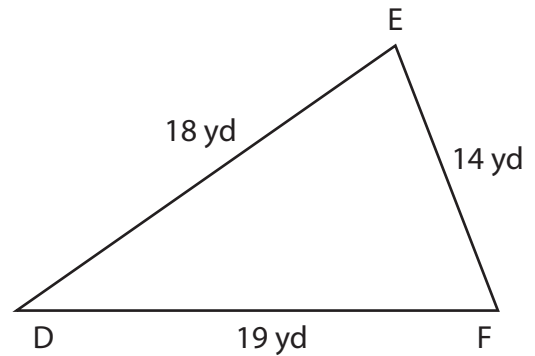

Smallest angle :

$\angle D$

Largest angle :

$\angle E$

Order the angles from smallest to largest angle in each triangle.

1)

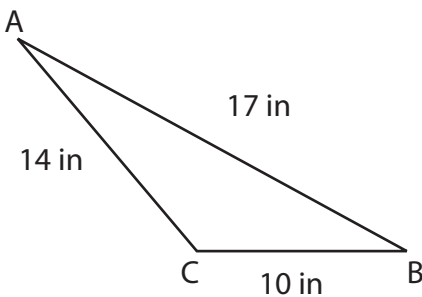

$\angle A, \angle B, \angle C$

2)

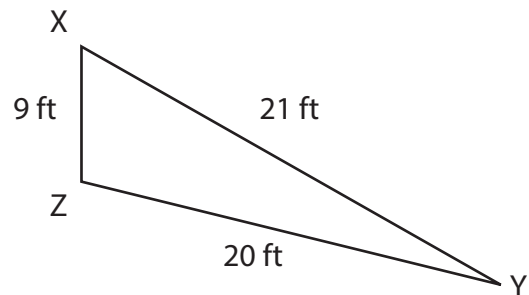

$\angle Y, \angle X, \angle Z$

Order the angles from largest to smallest angle in each triangle.

1)

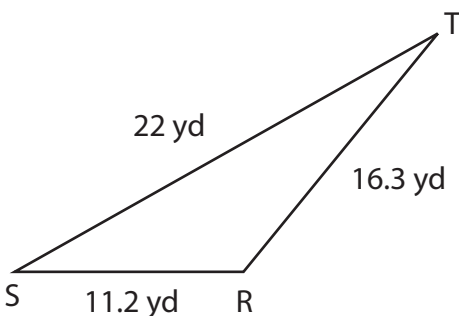

$\angle R, \angle S, \angle T$

3)

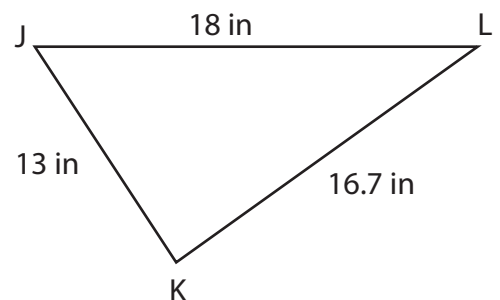

$\angle K, \angle J, \angle L$