



# PLACE VALUE-ABACUS

Name \_\_\_\_\_

Score \_\_\_\_\_

PV:II:37

Write the numbers shown on each abacus.

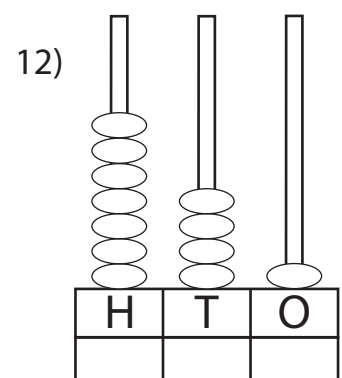
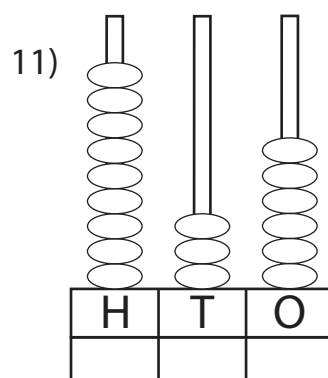
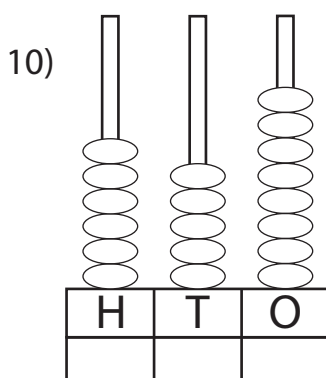
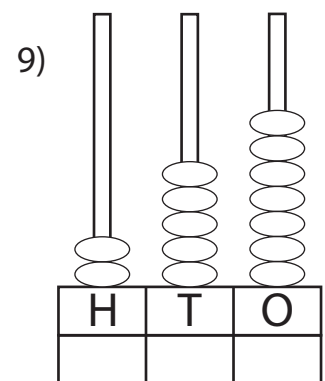
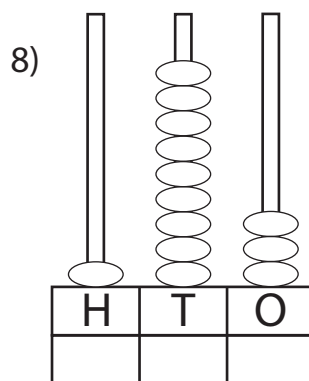
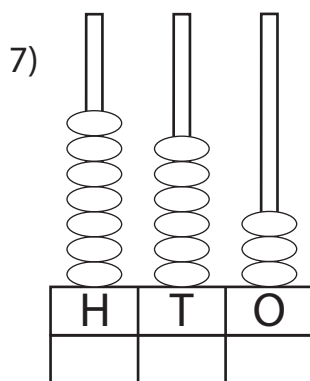
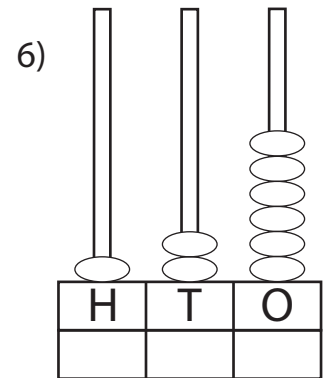
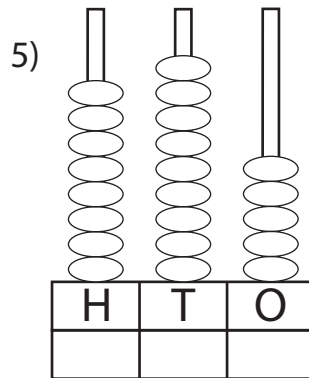
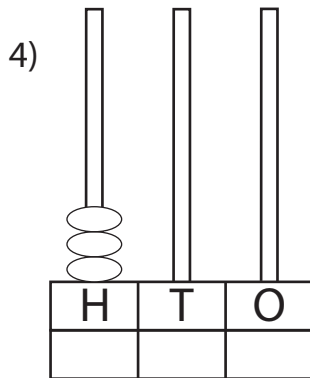
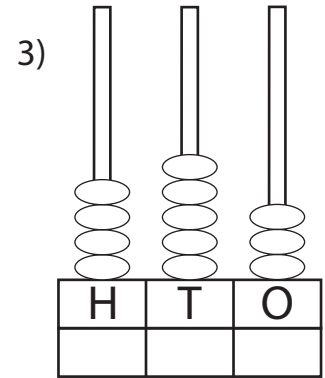
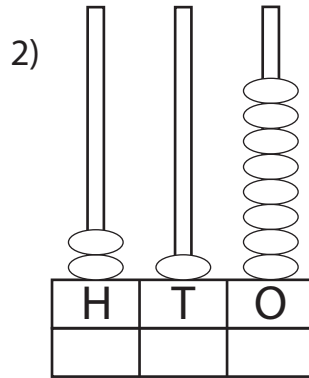
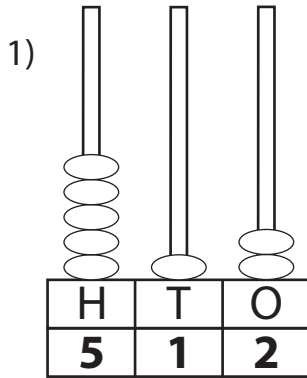



# PLACE VALUE-ABACUS

Name \_\_\_\_\_

Score \_\_\_\_\_

## Answer key

PV:II:37

Write the numbers shown on each abacus.

