



PERIMETER OF TRIANGLES

Name _____

Score _____

PT:35

Take not more than 5 minutes. Quickly calculate the perimeter of the triangles shown below. Also color the triangles yellow whose perimeter is greater than 14.1 mm and the rest pink.

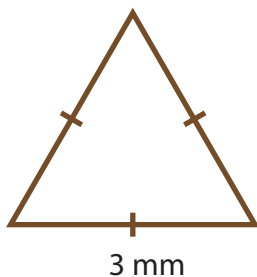
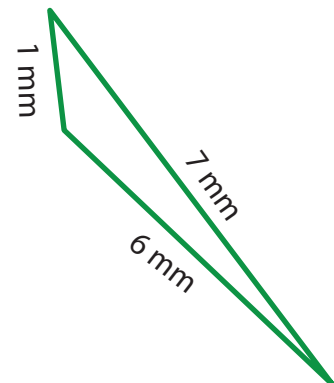
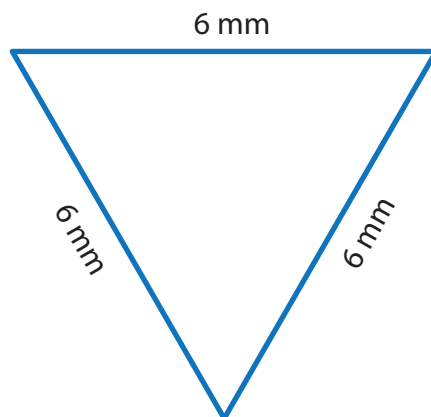
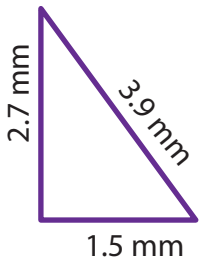
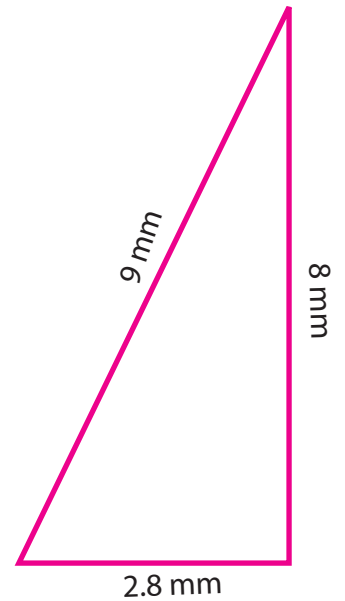
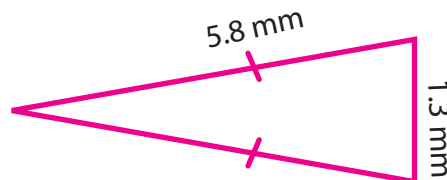
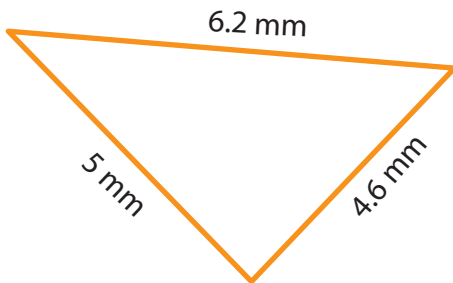
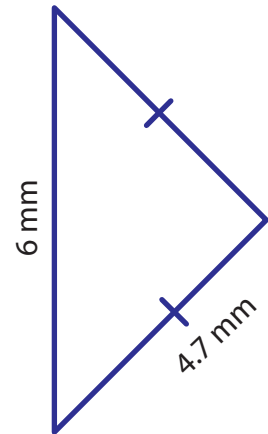
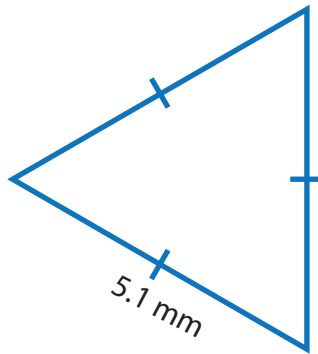
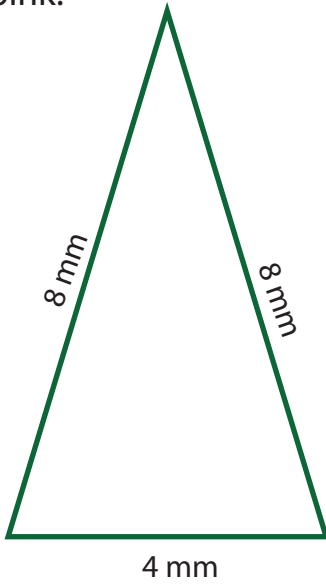



PERIMETER OF TRIANGLES

Name _____

Score _____

Answer key

PT:35

Take not more than 5 minutes. Quickly calculate the perimeter of the triangles shown below. Also color the triangles yellow whose perimeter is greater than 14.1 mm and the rest pink.

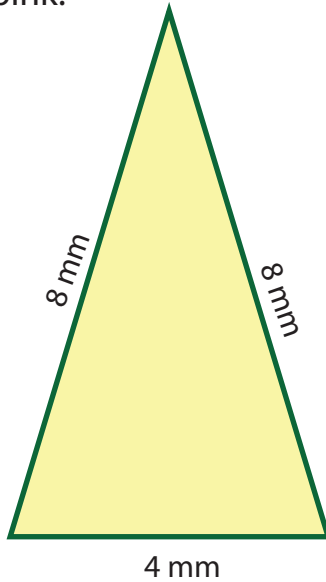

$$P = 20 \text{ mm}$$

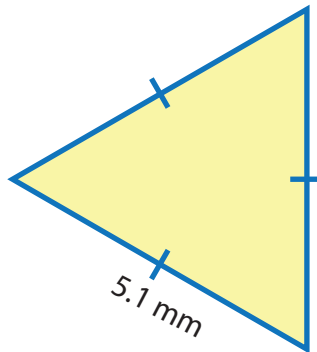

$$P = 15.3 \text{ mm}$$

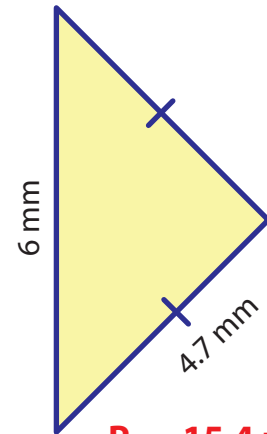

$$P = 15.4 \text{ mm}$$

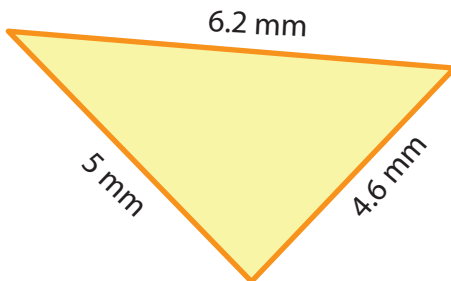

$$P = 15.8 \text{ mm}$$

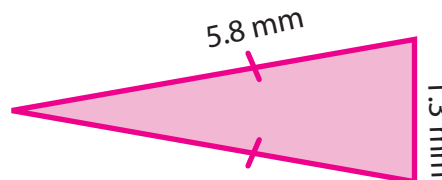

$$P = 12.9 \text{ mm}$$

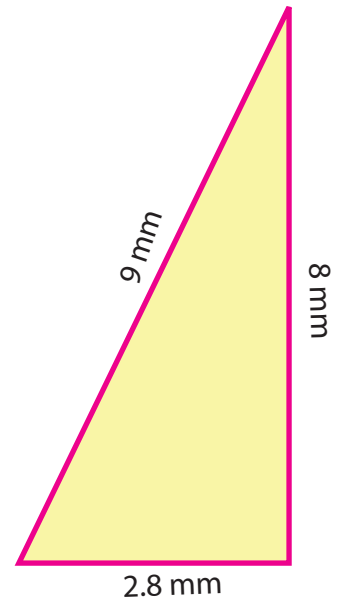

$$P = 19.8 \text{ mm}$$

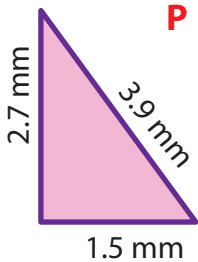

$$P = 8.1 \text{ mm}$$

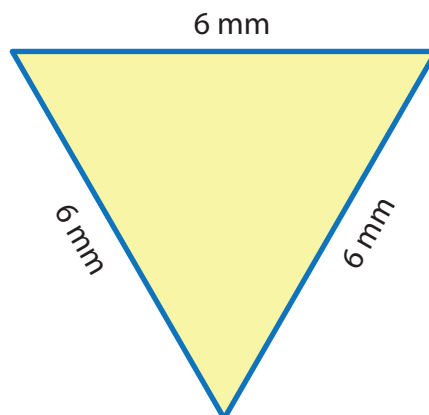

$$P = 18 \text{ mm}$$

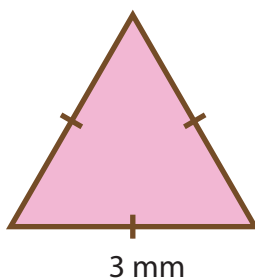

$$P = 9 \text{ mm}$$

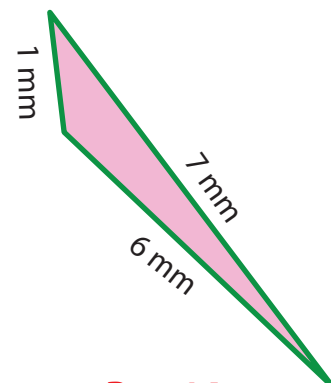

$$P = 14 \text{ mm}$$