



Perimeter of Quadrilateral

Name _____

Score _____

PQ:21

Find x.

1)

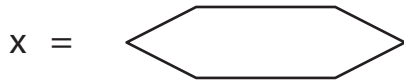
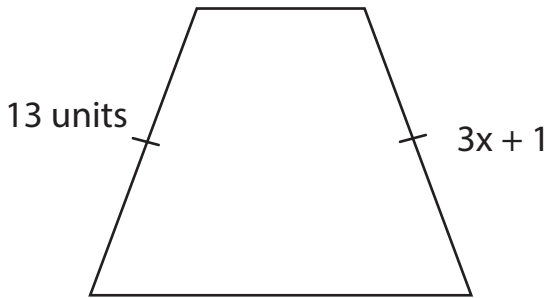

2)

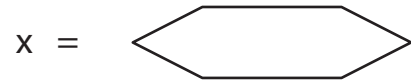
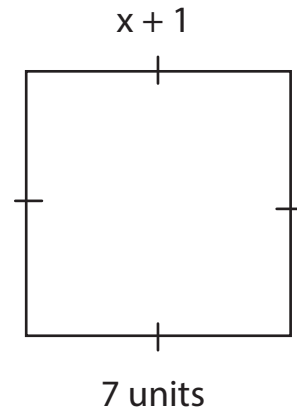

3)

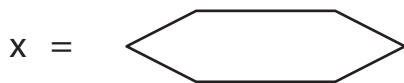
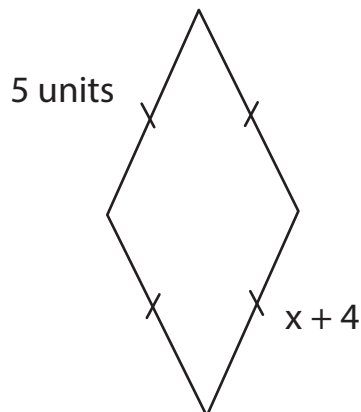

4)

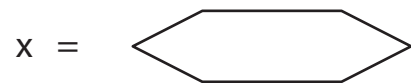
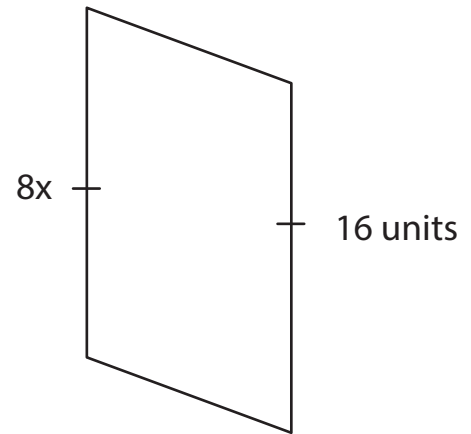

5) Perimeter = 40 units

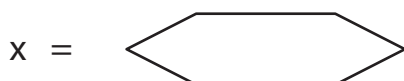
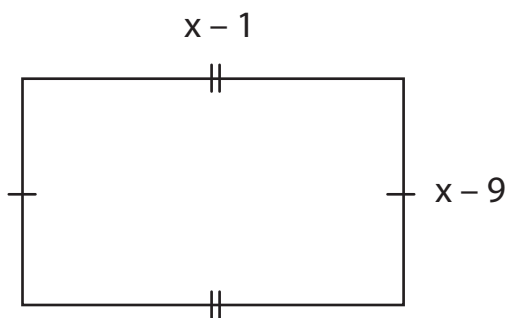

6) Perimeter = 24 units

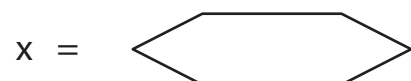
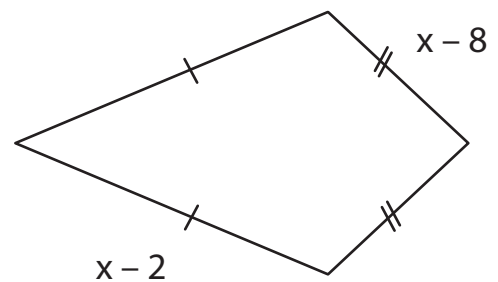



Perimeter of Quadrilateral

Name _____

Score _____

Answer key

PQ:21

Find x.

1)

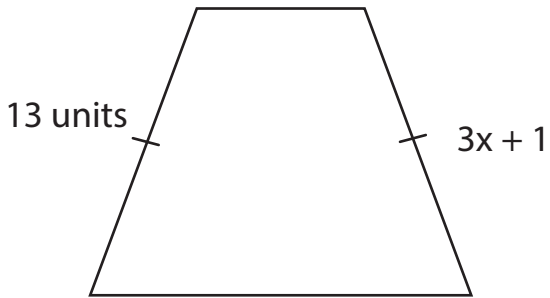

x =  **4**

3)

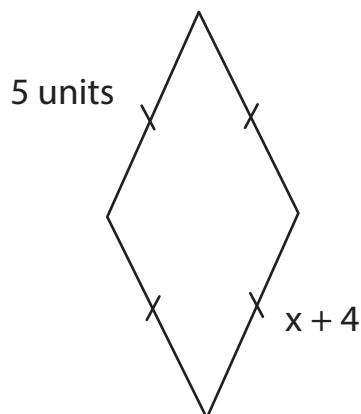

x =  **1**

5) Perimeter = 40 units

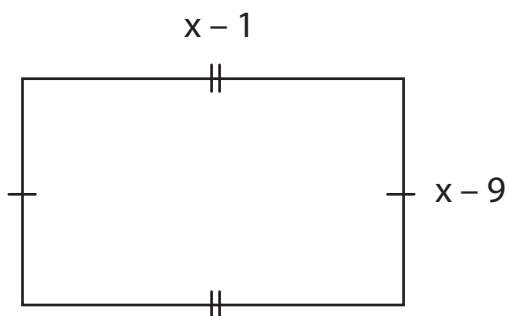

x =  **15**

2)

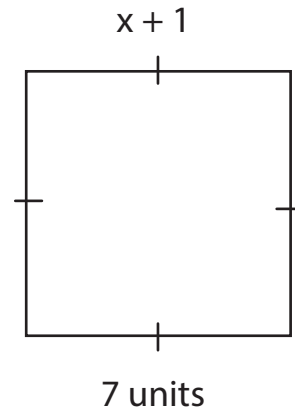

x =  **6**

4)

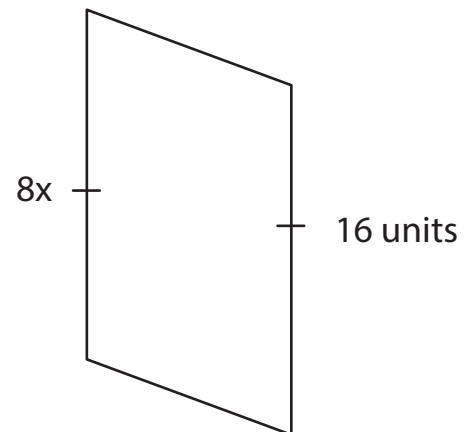

x =  **2**

6) Perimeter = 24 units

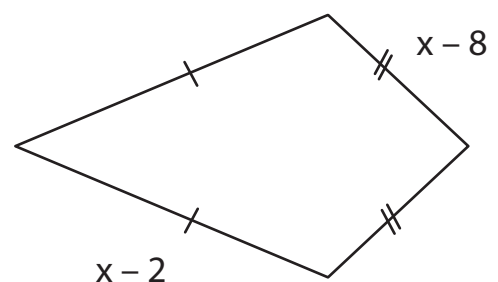

x =  **11**