



Linear Pairs of Angles

Name _____

Score _____

PA:30

Find the unknown angle.

1)

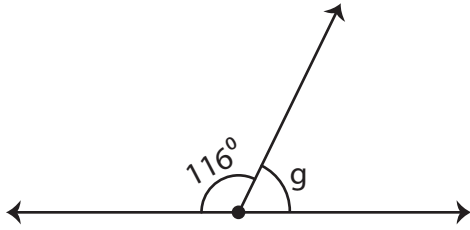

$g =$ _____

2)

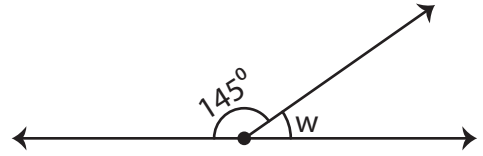

$w =$ _____

3)

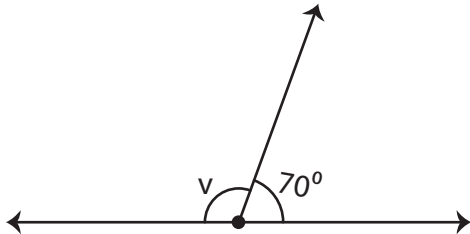

$v =$ _____

4)

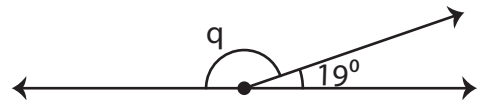

$q =$ _____

Find the value of x.

1)

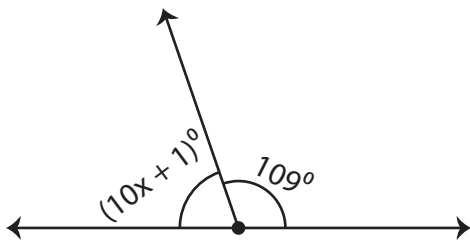

$x =$ _____

2)

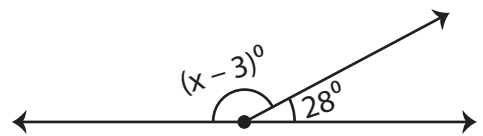

$x =$ _____

3)

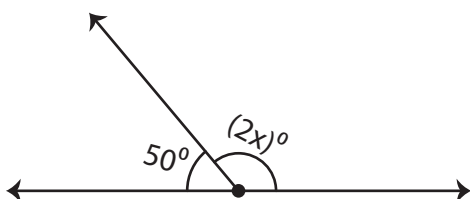

$x =$ _____

4)

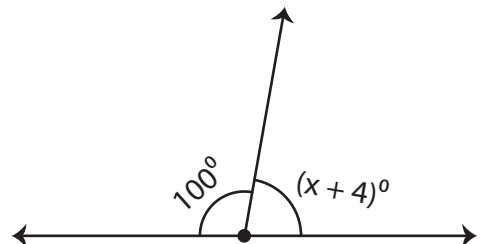

$x =$ _____



Linear Pairs of Angles

Name _____

Score _____

Answer key

PA:30

Find the unknown angle.

1)

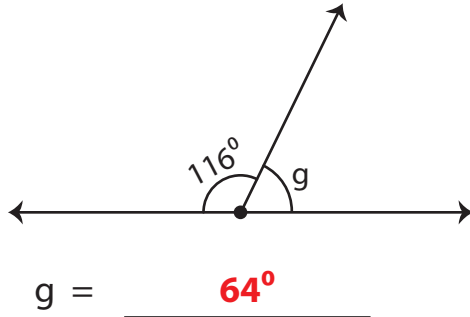

2)

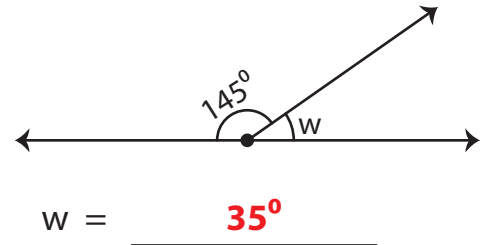

3)

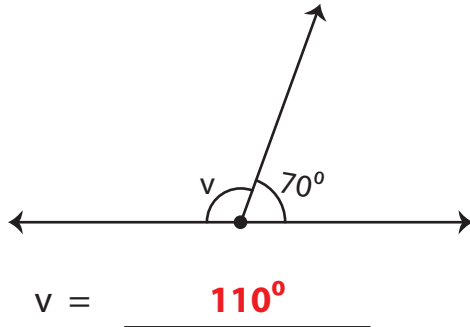

4)

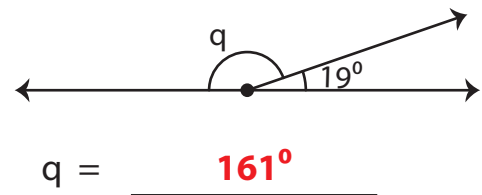

Find the value of x.

1)

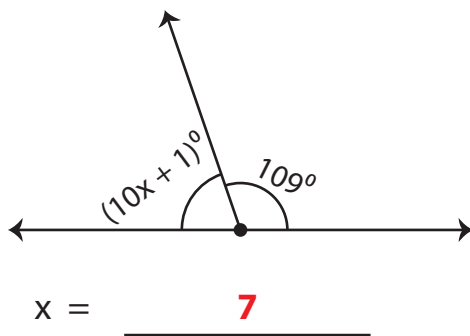

2)

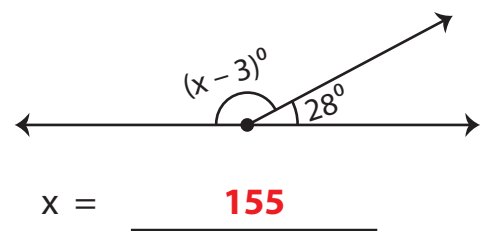

3)

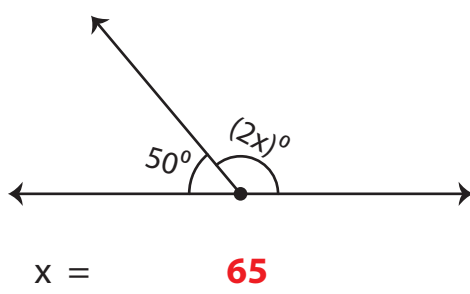

4)

