



Perimeter of Kites

Name _____

Score _____

KK:10

Find the perimeter of each kite.

1)

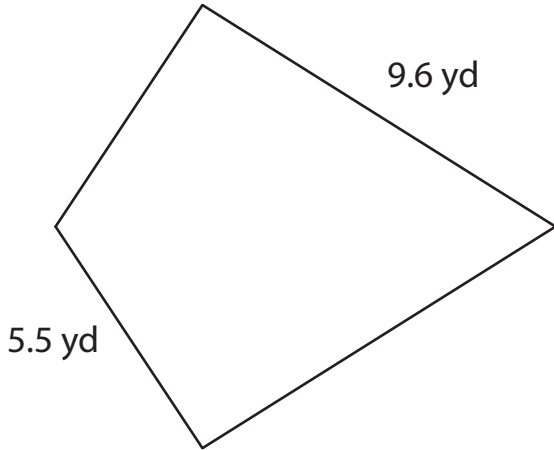

Perimeter = 

2)

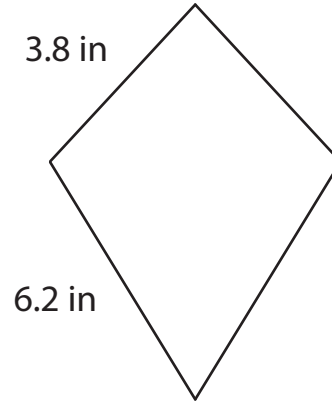

Perimeter = 

3)

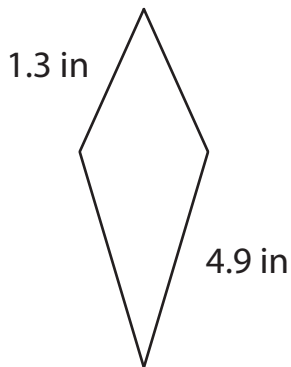

Perimeter = 

4)

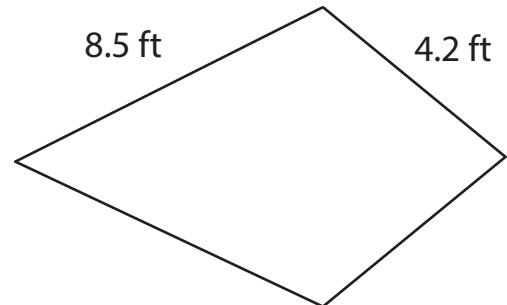

Perimeter = 

5)

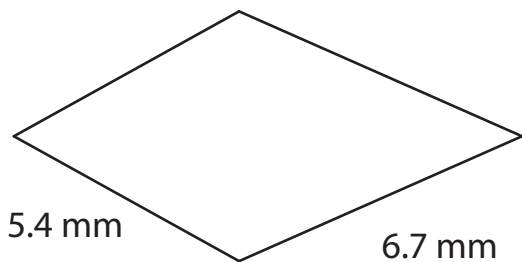

Perimeter = 

6)

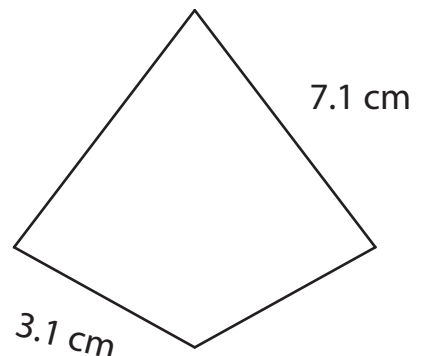

Perimeter = 



Perimeter of Kites

Name _____

Score _____

Answer key

KK:10

Find the perimeter of each kite.

1)

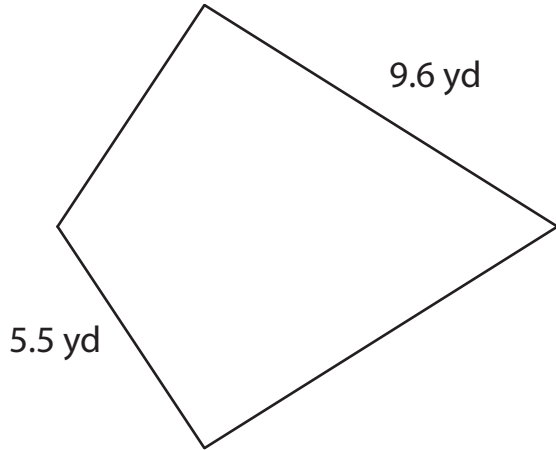

Perimeter = **30.2 yd**

2)

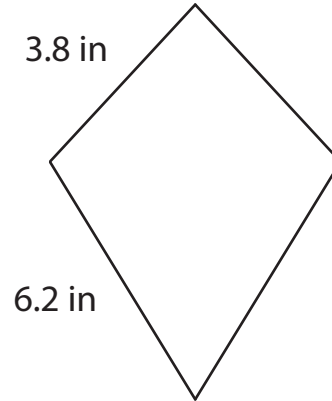

Perimeter = **20 in**

3)

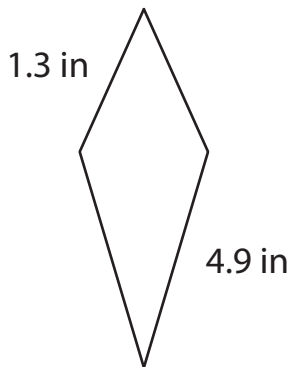

Perimeter = **12.4 in**

4)

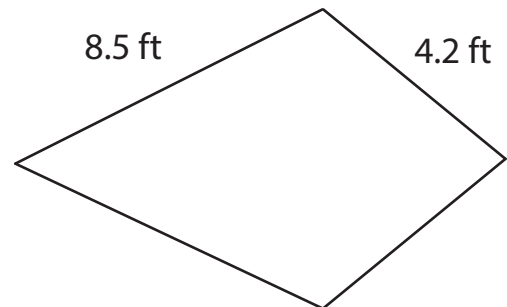

Perimeter = **25.4 ft**

5)

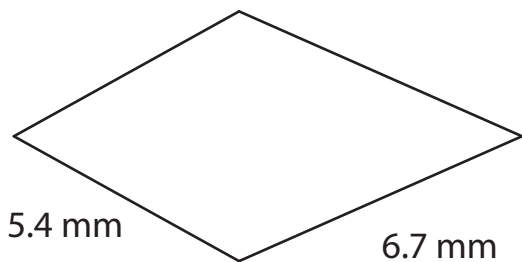

Perimeter = **24.2 mm**

6)

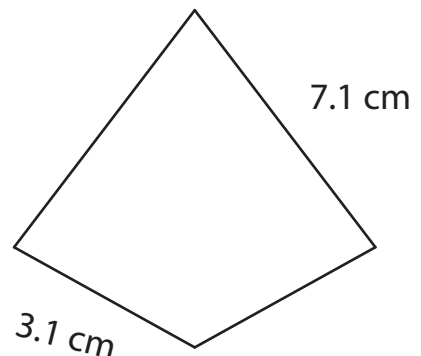

Perimeter = **20.4 cm**