



KINDERGARTEN

PICTURE ADDITION

WORKBOOK 1

1 gift box + 3 gift boxes = 4

2 Santa hats + 5 Santa hats = 7

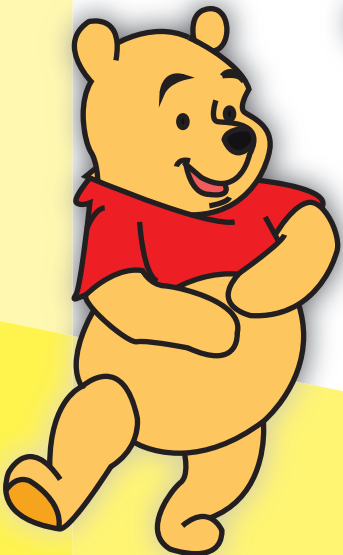



Picture Addition

Date _____

Count and add the pictures.

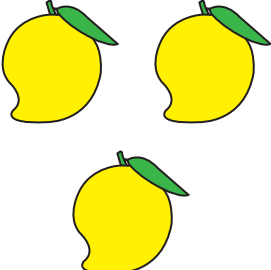
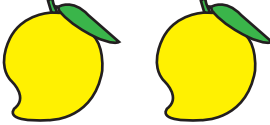
1)  +  =

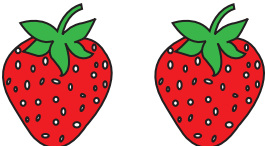
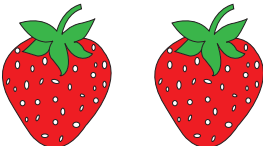
2)  +  =

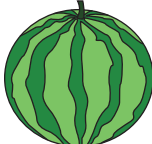
3)  +  =

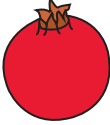
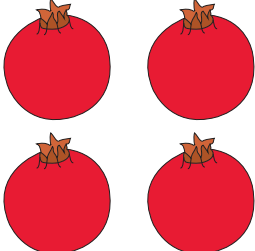
4)  +  =

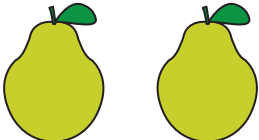
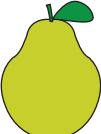
5)  +  =



Date _____

Count and add the pictures.

1)



+



=

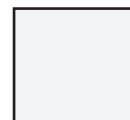

2)

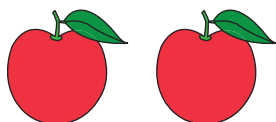

+

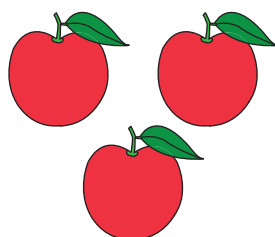

=

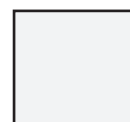

3)

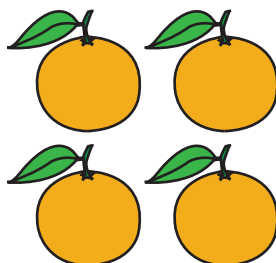

+



=



4)

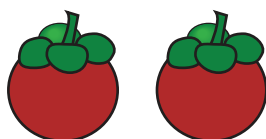

+

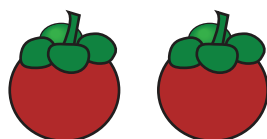

=



5)



+

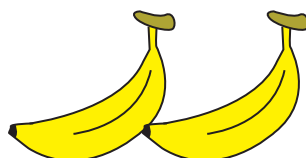

=

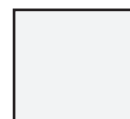



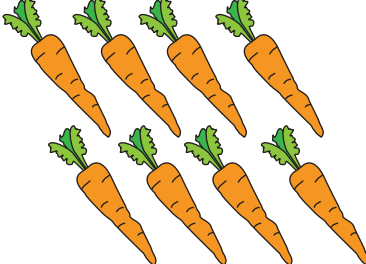
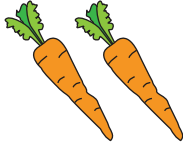

Date _____

Count and add the pictures.

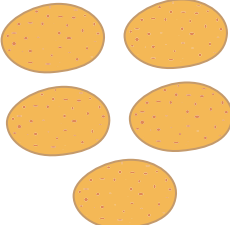
1)  +  =

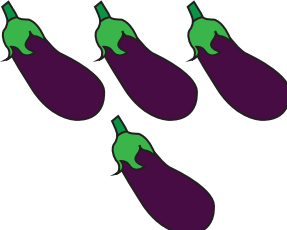
2)  +  =

3)  +  =

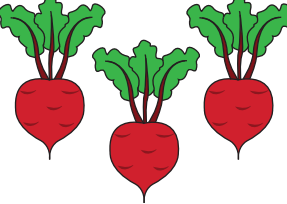
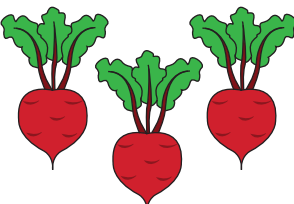
4)  +  =

5)  +  =



Date _____

Count and add the pictures.

1)

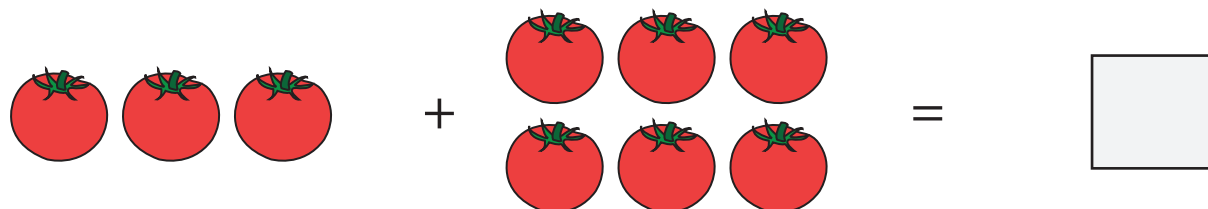

2)



3)

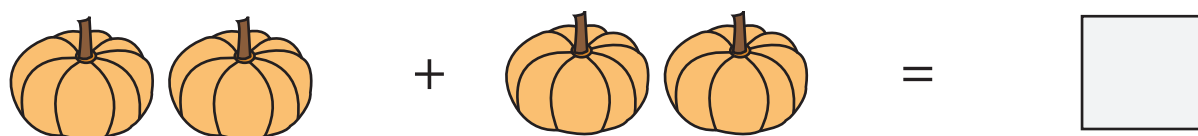

4)



5)

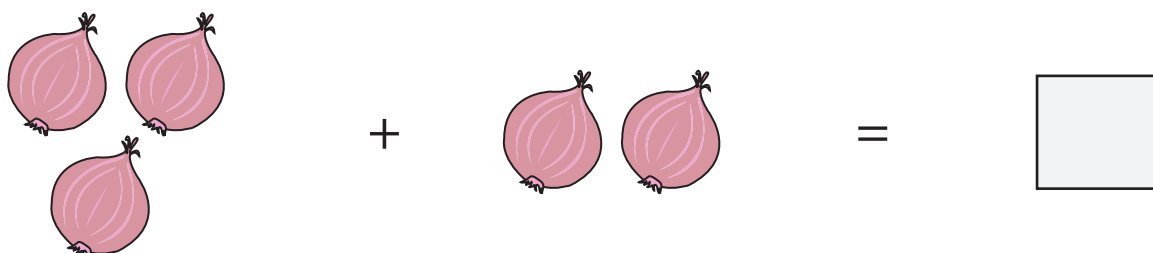



Date _____

Count the pictures, write them down and sum up.

1)

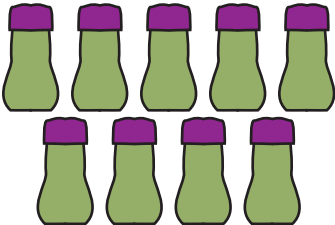

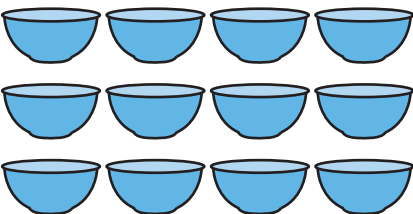

+ =

2)

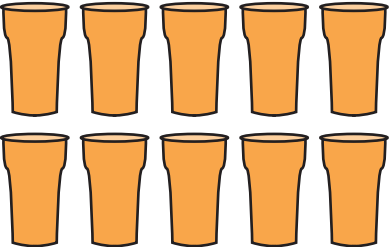

+ =

3)



+ =

4)

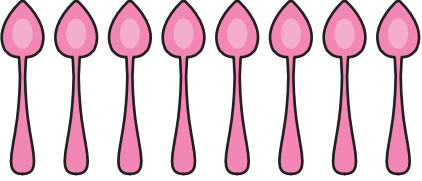
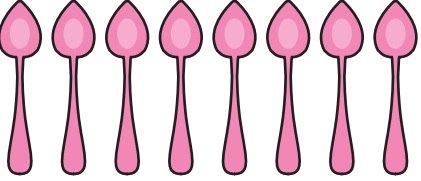

+ =



Count the pictures, write them down and sum up.

1)

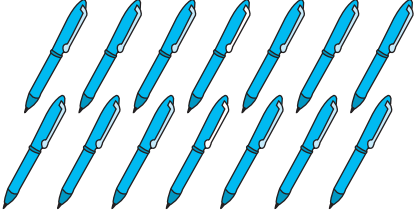
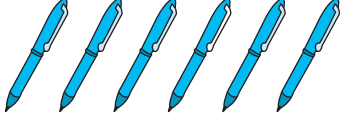

+ =

2)

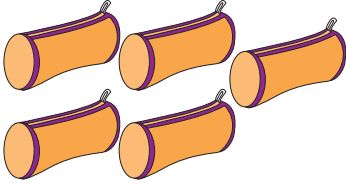
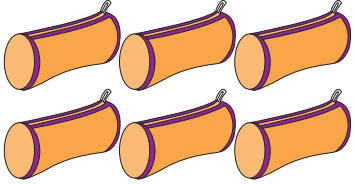

+ =

3)

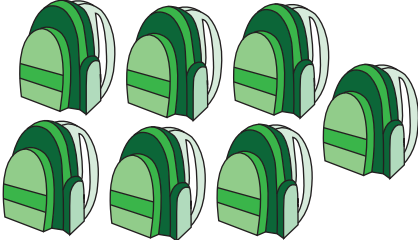
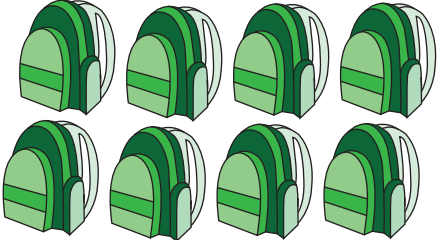

+ =

4)

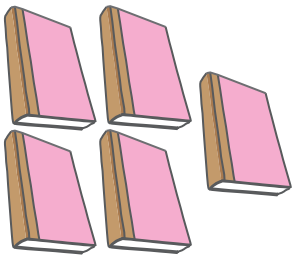
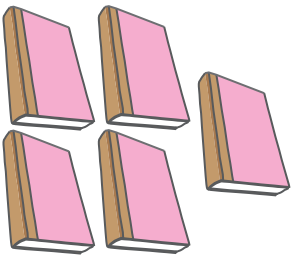



+ =





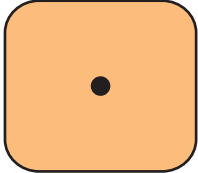
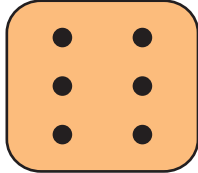

Dice Addition

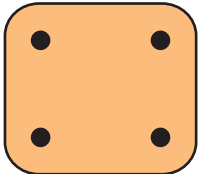
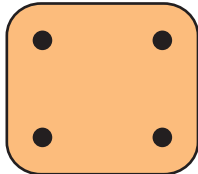

Date _____

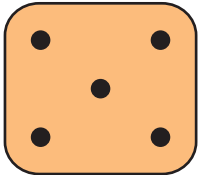
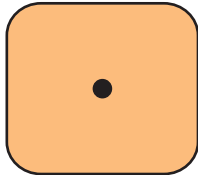

Count the dots on each die and add them.

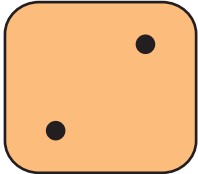
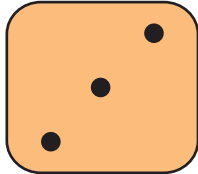

1)  +  = 

2)  +  = 

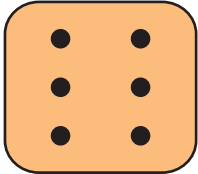
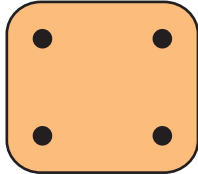
3)  +  = 

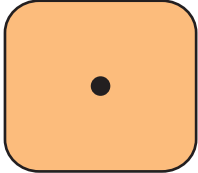
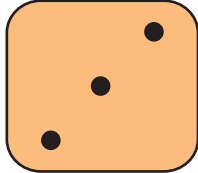

4)  +  = 



5)  +  = 

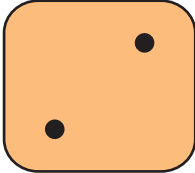
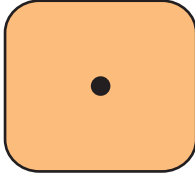

6)  +  = 



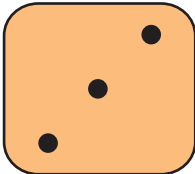
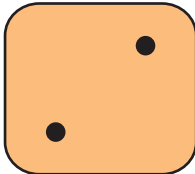

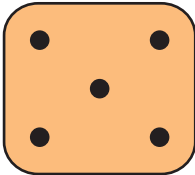
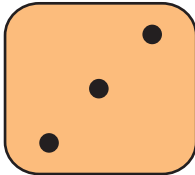

Count the dots on each die and add them.

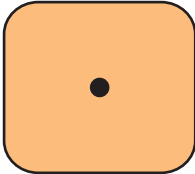
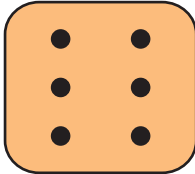

1)  +  = 

2)  +  = 

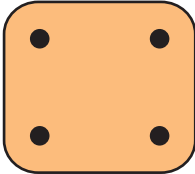
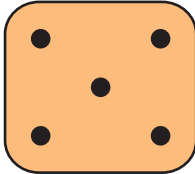
3)  +  = 

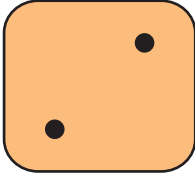
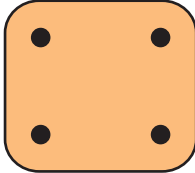

4)  +  = 

5)  +  = 



6)  +  = 

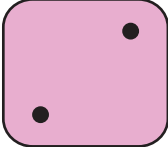

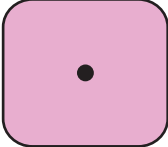
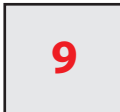

Count the dots on each die, write them down and sum up.

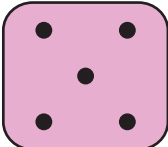
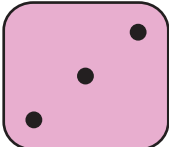
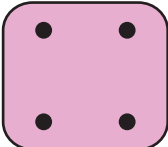
1)  +  +  = 

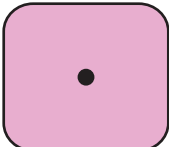
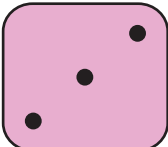

+ + =

2)  +  +  = 



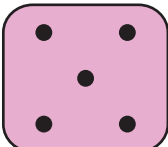
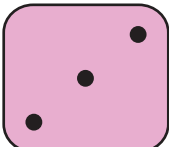
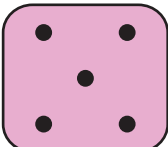

+ + =

3)  +  +  = 

+ + =

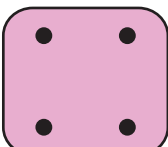
4)  +  +  = 

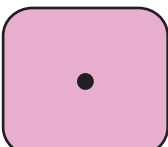

+ + =

5)  +  +  = 

+ + =



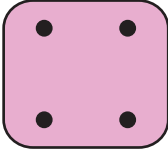

Count the dots on each die, write them down and sum up.

1)  +  +  = 

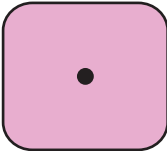
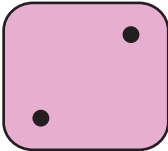
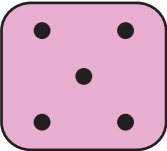
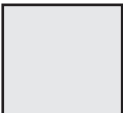

+ + =

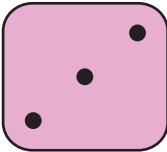
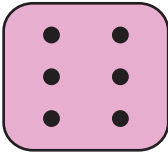
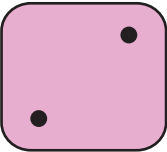
2)  +  +  = 

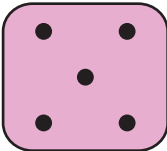
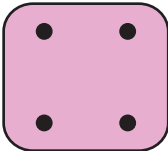
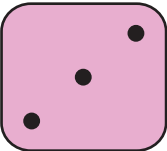

+ + =

3)  +  +  = 

+ + =

4)  +  +  = 

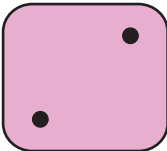
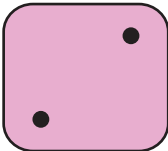
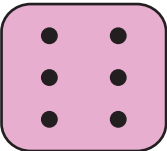
+ + =

5)  +  +  = 



+ + =





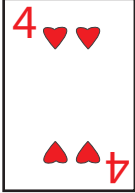
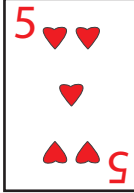

Card Addition

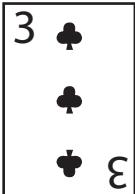
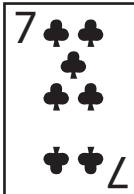

Date _____

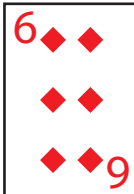

Count the numbers written on each card and fill the boxes.

1)  +  = 

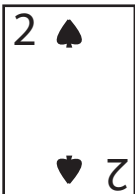
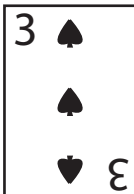
2)  +  = 

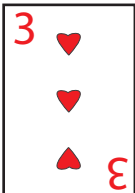
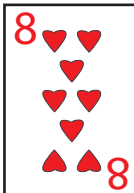

3)  +  = 



4)  +  = 

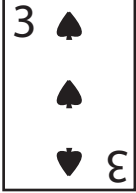
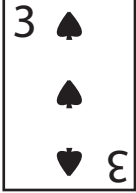

5)  +  = 



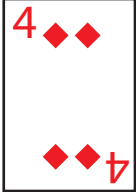

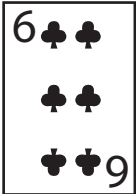
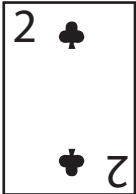

Count the numbers written on each card and fill the boxes.

1)  +  = 

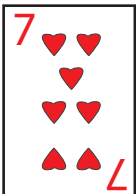
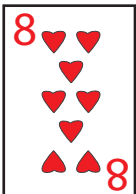
2)  +  = 

3)  +  = 

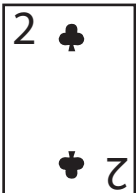
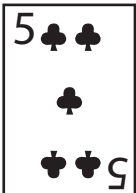
4)  +  = 

5)  +  = 



Date _____

Count the shapes.

1)

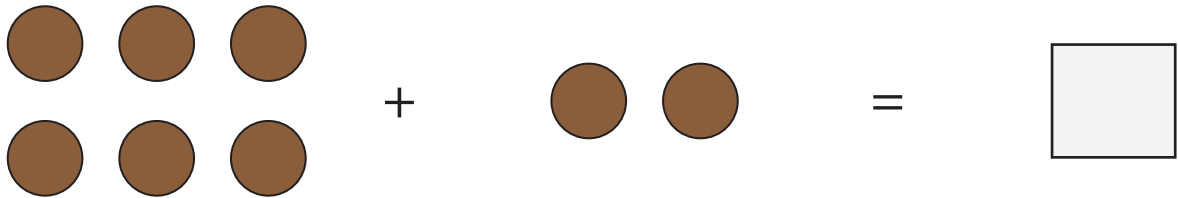

2)

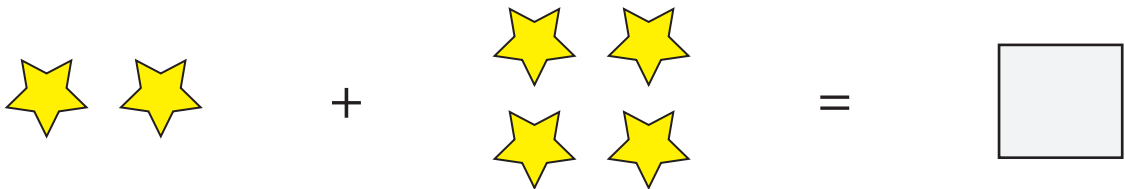

3)

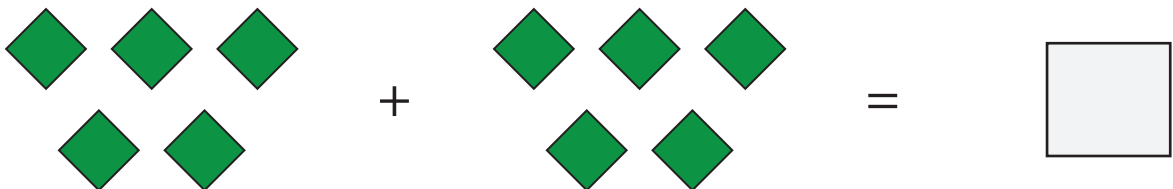

4)



5)

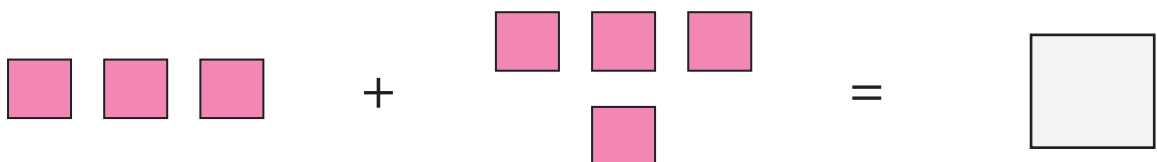



Date _____

Count and add the shapes.

1)

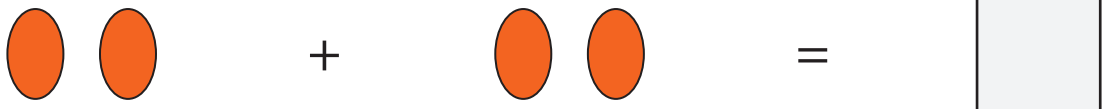

2)

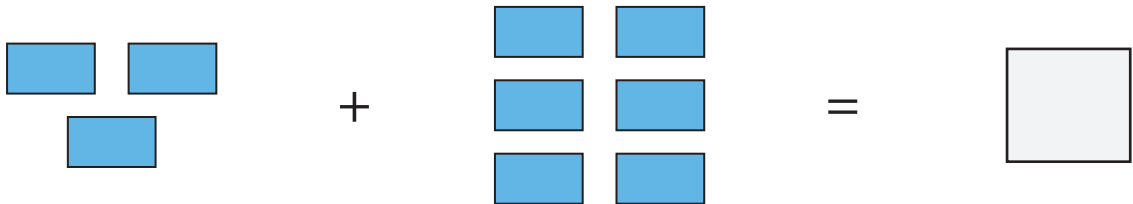

3)

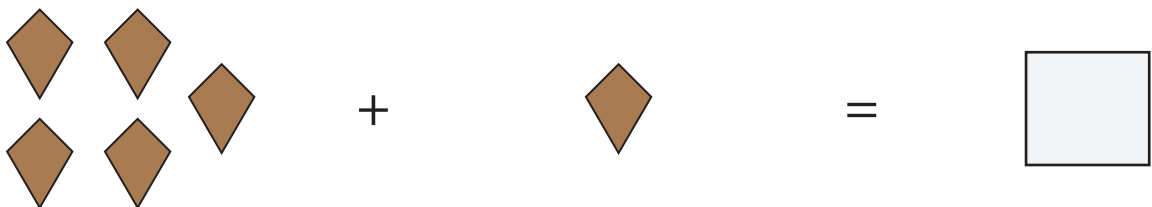

4)

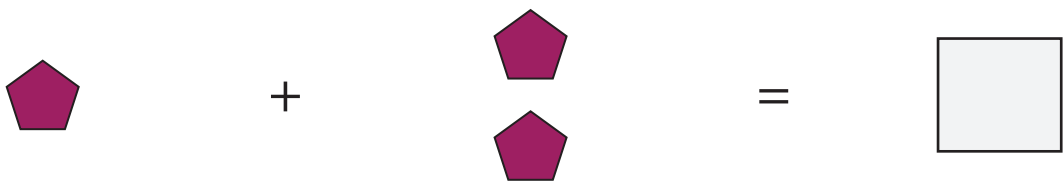

5)

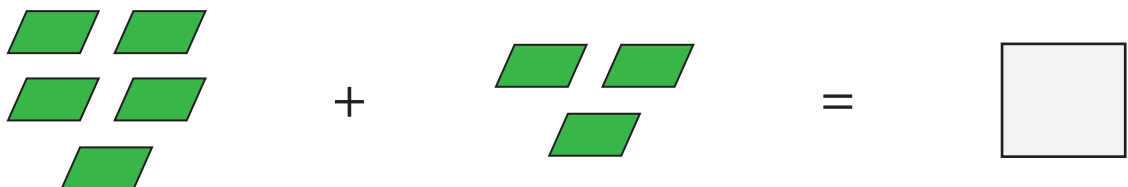



Count and add the shapes.

1)

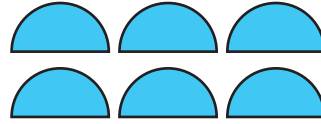
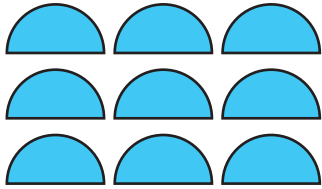

+



=



2)

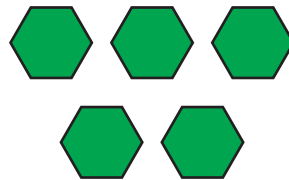
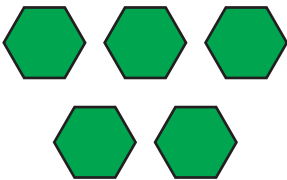

+



=



3)

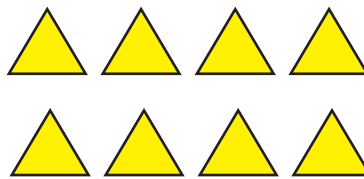
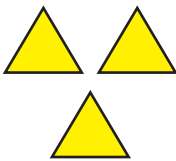

+



=



4)

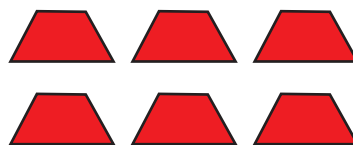
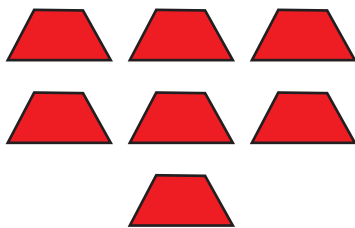

+



=





Date _____

Count and add the shapes.

1)

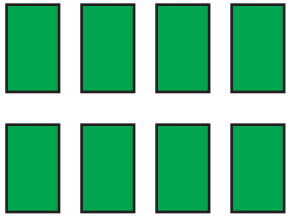

+



=



2)

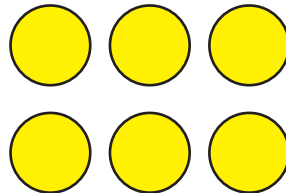
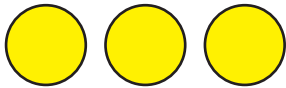

+



=



3)

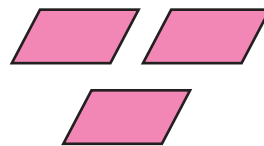
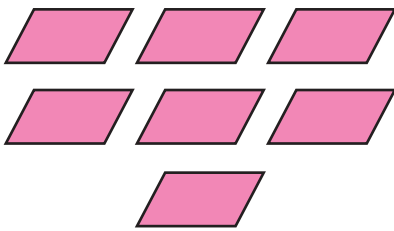

+



=



4)

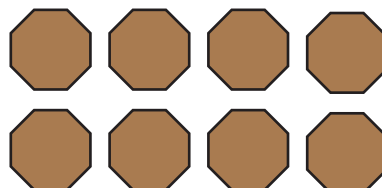
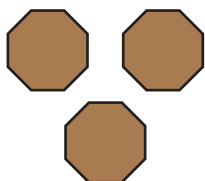

+



=

